

# Magroll™

## 95mm Industrial Insulated Roller Doors



# Magroll™

- Designed for both industrial and domestic use.
- Very strong yet light at just 11.3kg per sq mtr.
- Laminated anti-scratch coating for extended lifespan.
- Also suitable for large domestic applications.



## Insulated Industrial Roller Door

Magroll™ 95mm Industrial Insulated Doors are the first one piece industrial lath to be produced in Ireland and the UK. Every aspect of this product has been carefully designed from the choice of material to the unique shape of the profile. Below are some of the advantages of choosing our superior product.

- Use of PVC laminate coated steel ensures long lifespan and superior anti-scratch/wear properties.
- With a one piece lath the PU insulation is bonded to the outer skins ensuring a very strong lath.
- The design of our lath ensures that the profile rolls into a much smaller roll than other two piece laths, which is good news for applications where space is limited.
- We have available an extruded bottom slat with rubber extruded profile to seal the door to floor.
- A unique extruded aluminium profile for attaching the top lath to the barrel is of great benefit, it allows a bolt to be welded to tube and the extruded profile conceals the head of bolt to avoid damaging the laths when rolling around the tube.
- 90mm side guides are also produced by ourselves which have holes pre-punched for fitting and two PVC brush carriers are pushed onto the profile to ensure a very quiet operation.



All doors individually matched to customer specific requirements for colour and size.





White  
RAL 9003

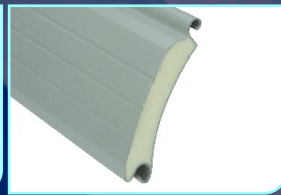

Goosewing Grey  
RAL 7038

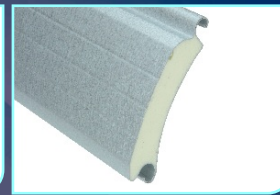

Galvanised

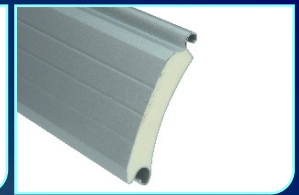

Silver  
RAL 9006

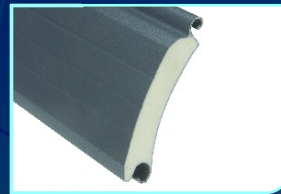

Dark Grey  
Nearest RAL 7011

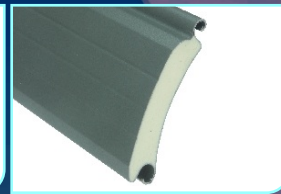

Merlin Grey  
BS18 B25

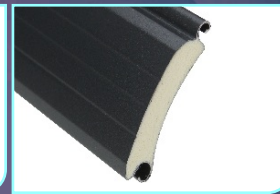

Anthracite  
RAL 7016

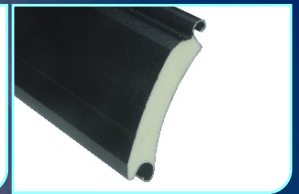

Black  
RAL 9005



Red



Moorland Green  
BS12 B21

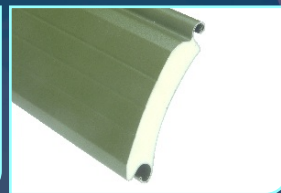

Olive Green  
RAL 6003

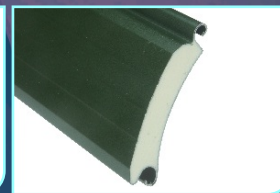

Dark Green  
Nearest RAL 6009

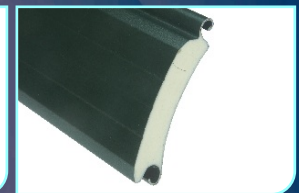

Juniper Green  
BS12 B29



Chili Red  
RAL 3000



Golden Oak

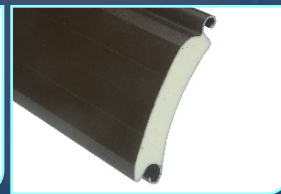

Van Dyke Brown  
RAL 8014

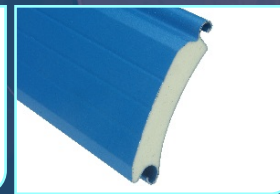

Solent Blue  
BS18 E53

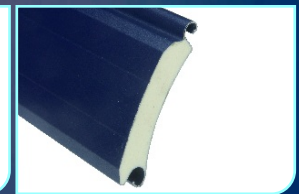

Sargasso  
Nearest RAL 5003

- Laminated coating provides superior anti-scratch resistance compared to painted surfaces.
- Wide variety of colours available for immediate manufacture.
- Textured finish for added durability.

## Multiple Industrial Installation





Commercial Installation



Domestic Installation



Industrial Installation



Dock Leveller Installation

# Magroll 90mm Guide

- 83 x 90mm roll formed guide rail. Manufactured from 2.5mm galvanised steel.
- Unique pre-punched guide rail offers easy fitting.
- Slotted holes allow for adjustment during installation and guide will be cut in 500mm increments from 2500mm - 8000mm.
- Guides can be cut to specific lengths without holes as per customer request.
- Snap-on PVC brush carrier with fixed mohair on both sides reduces heat loss and ensures quiet operation.
- The Magroll 90mm guide system can be used with or without wind locks.

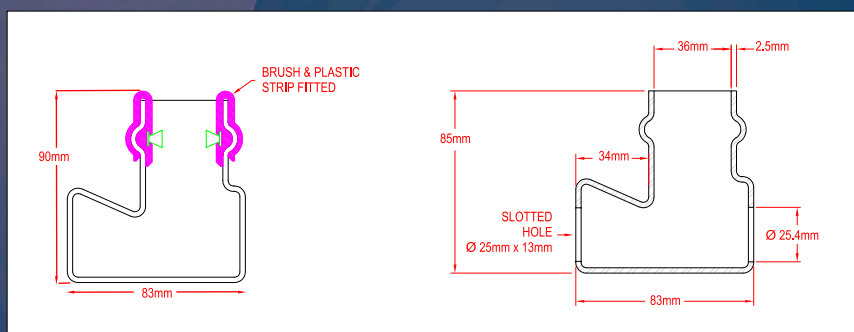
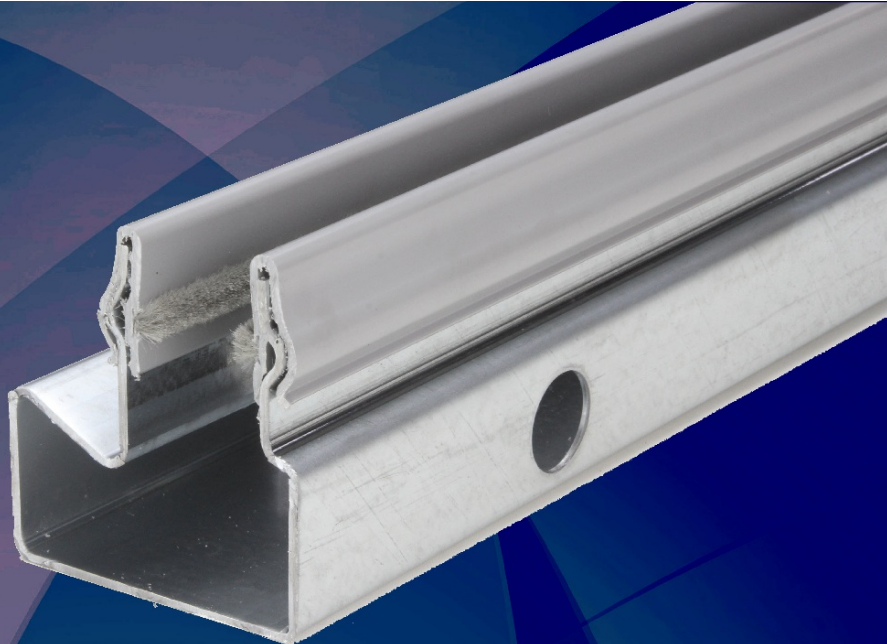

## Top Hanger

- Unique top hanger (Barrel Lath) suitable for 127mm or 139mm barrel or greater (5" or 5.5" inches).
- Recessed hanger design conceals 10mm nut and bolt fixing.
- Hanger profile protects lath during operation.
- Supplied at 360mm with an 11mm pre-drilled hole.



## Bottom Rail

- Aluminum extruded bottom rail with weather seal.
- Special air cushion rubber strip ensures solid seal from door to door.
- Solid design provides increased level of security.



## Bottom Rail with Safe Edge

## Windows

- Dimensions 170mm x 45mm.
- Windows may be placed across the lath at standard 230mm or 350mm centres.
- Can be strategically placed if desired at customers request.



## Wind Locks

- Wind locks held in position by 4 rivets.
- Factory fitted in pairs.

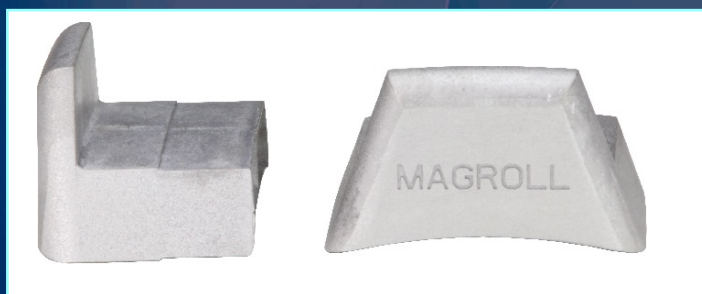

## End Locks

- Easy to install tap in end locks.
- End locks are supplied in right and left hand pairs.





## Acoustic Test

The sound reduction capability of the roller door has been tested and found to produce a level difference of 22dB inclusive of flanking effects at the test location.

## Air Permeability

Measured at 1.95 m<sup>3</sup>.h<sup>-1</sup>.m<sup>-2</sup> @50Pa.

## Wind Test

Tested to category 5 wind load.

## Thermal Test

Thermally tested assembled curtain to 3.3 W/m<sup>2</sup>k.

## Magroll 95mm Barrel Wrap Chart

The below chart is calculated as follows

- (A) Opening Height of Door.
  - (B) Dimension from centre of barrel to fixing surface
- Tube size used in this calculation is 139.7mm.

A	B
2500mm	180mm
3000mm	200mm
3500mm	210mm
4000mm	230mm
4500mm	230mm
5000mm	230mm
5500mm	250mm
6000mm	250mm

Order ready for transport



# Magroll™

Authorised Distributor



[info@acclaimindustrialdoors.co.uk](mailto:info@acclaimindustrialdoors.co.uk)

Tel: 07739909702 or 01778348664